

Data Sheet



Article number: 2302083443

Description: E+G Lock knob
VTR.40 p-M6x40

Measures

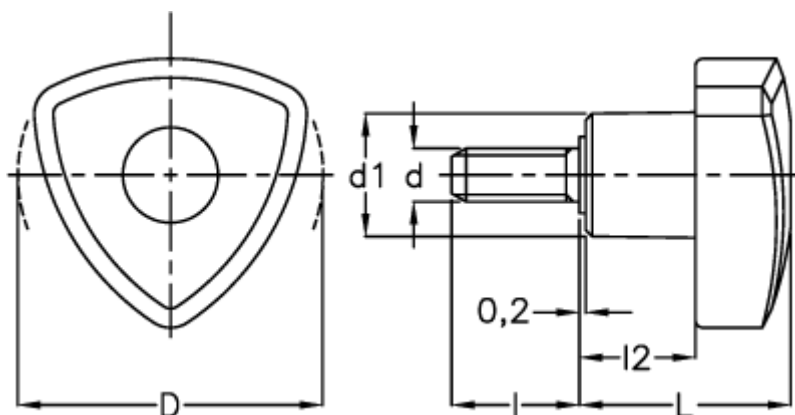

d = 40

d1 = 16

d 6g = M6

l = 40

L = 30

l2 = 17